



## **Improvements in Glass Encapsulation Technology Offer Significant Advantages for Implantable Medical Devices**

By

Frédéric Mauron  
Senior VP, Biomedical Engineering  
Director, Business & Administration  
Valtronic SA

The most recent advances in glass encapsulation of microelectronic devices offer important benefits to the developers of “smart” implantable medical devices. These benefits include reduced risk of damage to encapsulated circuitry, high biocompatibility, superior hermeticity, and good mechanical stability.

Smart implants (sometimes called *active implants*) are designed to provide in-vivo diagnostic biofeedback on a patient’s condition (blood glucose, intra-ocular pressure, etc.) and/or to provide treatment (such as neurostimulators for the treatment of epilepsy, implantable drug pumps, cochlear implants, and a growing range of others). Often, a smart implant is part of a microsystem designed to measure and transmit diagnostic data, which must function autonomously over its intended lifespan, which might be a single day or several decades long.

### **Glass vs. Alternative Encapsulation Materials**

Glass encapsulation offers several advantages over common smart implant encapsulation materials such as titanium and titanium alloys. Because of its strength and other features, titanium has long been used in medical implants such as cardiac pacemakers and defibrillators, as well as in replacement hip, knee, shoulder and elbow joints. However, sealing titanium

implants against moisture requires the use of a high temperature laser welding technique, so the implants must be substantially larger than they would otherwise be in order to minimize the risk of damaging the circuitry during the welding process. In contrast, the newest “cold-welding” glass encapsulation techniques allow creating significantly smaller implants than those housed in titanium. Smaller, less invasive implants are easier both for the doctor to implant and for the patient to tolerate. This underscores another disadvantage of titanium in that it offers less than optimal hermeticity (resistance to leakage) for small volumes.

In contrast with titanium or its alloys, glass encapsulation offers superior transmission of the radio frequency (RF) signals typically used to send bio data to an external reader or to allow recharging of a rechargeable on-board battery. A typical titanium smart implant requires mounting a relatively large antenna onto the implant’s PCB in order to provide sufficient power to transmit RF signals through the housing. In contrast, glass encapsulation is largely transparent to radio signals, so significantly less power is needed to transmit a signal. This allows designers of smart implants to employ smaller antennae and, in turn, create smaller implants.

Glass encapsulation offers greater biocompatibility over extended periods than many other implant packaging materials. For example, titanium has been in use in medical applications for decades and is generally considered to offer high biocompatibility; however, allergic reactions to it are not unknown.

Several other implant encapsulation materials have also been used over the years, including silicone and multilayer epoxies. However, silicone lacks glass’s long durability and high resistance to body fluids, which are essential for long-term applications such as pacemakers or neurostimulators. It is best suited for short-term (24 to 48 hours) diagnostic use, such as for monitoring pressure variations in a patient’s intraocular lens as part of treatment for glaucoma.

Multilayer epoxy encapsulants have a long history of medical applications with their optimal use being implants with a medium-term (30 days to six months) life. A typical multilayer epoxy application might be a dental implant that measures moisture in a patient's mouth, then stimulates the submandibular gland to produce more saliva.

### **The Next Generation of Smart Implants**

The use of glass encapsulation can help developers of the next generation of smart implants face a variety of technical challenges. Extending the life of an implant's power supply is a constant concern among implant designers. For example, the battery in a pacemaker or defibrillator typically lasts anywhere from 5 to 15 years, depending on a variety of factors; however, replacing the battery is no simple matter because it actually requires surgery to replace the entire unit. Some researchers are exploring ways to extend the battery's life, perhaps by recharging it remotely from outside the body, via an external RF link. Others are considering the use of various body energy harvesting techniques, drawing on sources such as the patient's heartbeat, blood flow inside the vessels, movement of the body parts, and changes in the body temperature and converting them into electrical energy. There's even been discussion of finding ways to convert the body's own natural salts and sugars into bio-fuel that could be used to power an implant. Glass encapsulation, with its high transparency to RF energy, will simplify this research, as well as that involved in the development of new implant communications and memory functions. Currently, researchers are investigating two main glass encapsulation technologies for use in smart implants: cylindrical glass encapsulation and planar glass encapsulation.

### **Applications for Glass Encapsulated Smart Implants**

Unlike some other encapsulation technologies, glass encapsulation offers the advantage of an

extended lifespan, typically from 1 to 10 years, and potentially much longer. Simple cylindrical glass encapsulated microchips have long been used in veterinary medicine to serve as passive identifiers (for pets, valuable livestock/racehorses, etc.). These battery-free devices are implanted under the animal's skin using a large-bore hypodermic needle. The microchip is designed to be activated by a low-power RF signal emitted by a scanner, which causes the microchip to transmit a unique, preprogrammed identification number.

Among human patients, typical applications of injectable cylindrical glass encapsulated implants include those developed for various biological sensing tasks, such as continuous monitoring of glucose in a diabetic patient's interstitial fluid. Future biological sensing applications may include implants designed to monitor a patient's blood pressure or cholesterol levels; one day, it may be possible to package a whole "lab on a chip." Applications of planar glass encapsulation (PGE) devices are likely to include far more dense circuitry and high lead counts (up to 100), for use in deep brain stimulation, such as for the treatment of epilepsy or Parkinson's disease, and monitoring of intracranial pressure.

### **Cylindrical Glass Encapsulation (CGE) Technology**

A variety of materials go into glass encapsulated implants in development today, including borosilicate and bioactive glass (bioglass), quartz, and Kovar Glass. These materials must conform with standards for biocompatibility (ISO 10993-1 Standard for biological evaluation of medical devices that are recognized by the U.S. Food and Drug Administration) and implant moisture tightness (protecting circuitry against breakdown due to moisture).

The dimensions of today's CGE implants (see *Figure 1*) make them increasingly injectable, with outside diameters from 4mm to 8mm, wall thicknesses of just 0.4–0.6mm, and

lengths from 12mm to 50mm. Valtronic is currently developing the technology necessary to encapsulate even smaller implants. A CGE implant typically consists only of one tubular glass component. The design of electrical feed-throughs (conductors used to connect two sides of a part, such as a circuit board) for this type of implant is currently under development. This implant design can be used where energy or signal flow are independent from such feed-throughs.

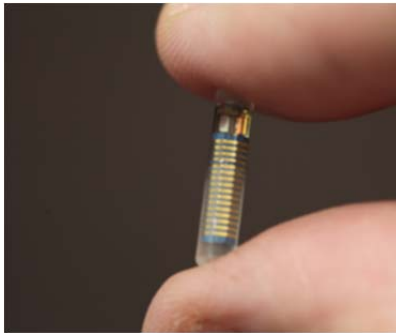

**Figure 1.** CGE implants can be small enough to be injected in a patient with a hypodermic needle.

### **Planar Glass Encapsulation (PGE) Technology**

As the name suggests, a planar glass encapsulated implant is flat rather than cylindrical (*Figure 2*). Often, this type of glass encapsulation can serve a function in addition to sealing the microelectronics inside, such as monitoring pressures (such as blood or intracranial) or one day possibly acting as a piezoelectric element to harvest mechanical energy produced by the patient's movements as a source of power for the implant.

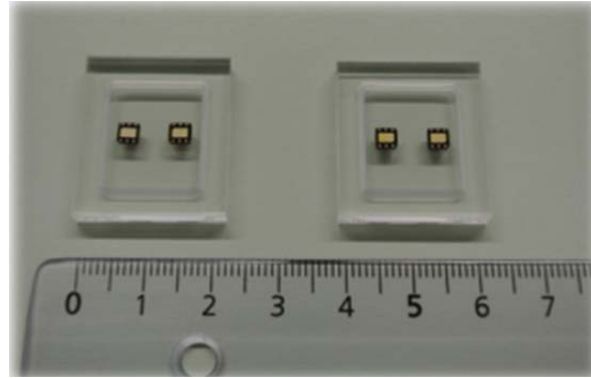

**Figure 2.** Compact planar glass encapsulated (PGE) implants.

The PGE assembly process (*Figure 3*) provides for high feature (leads) density in extremely small implants and high hermeticity. Feed-throughs are implanted in the bottom glass shell of the encapsulation “sandwich.” Next, the tungsten vias are gold plated, followed by the application of gold contacts to the inner and outer surfaces of the glass. After the implant’s internal electronics are connected, the top glass shell is added and welded to the bottom glass shell. The last step is the addition of lead interconnections to allow integrating the implant into the patient’s body.

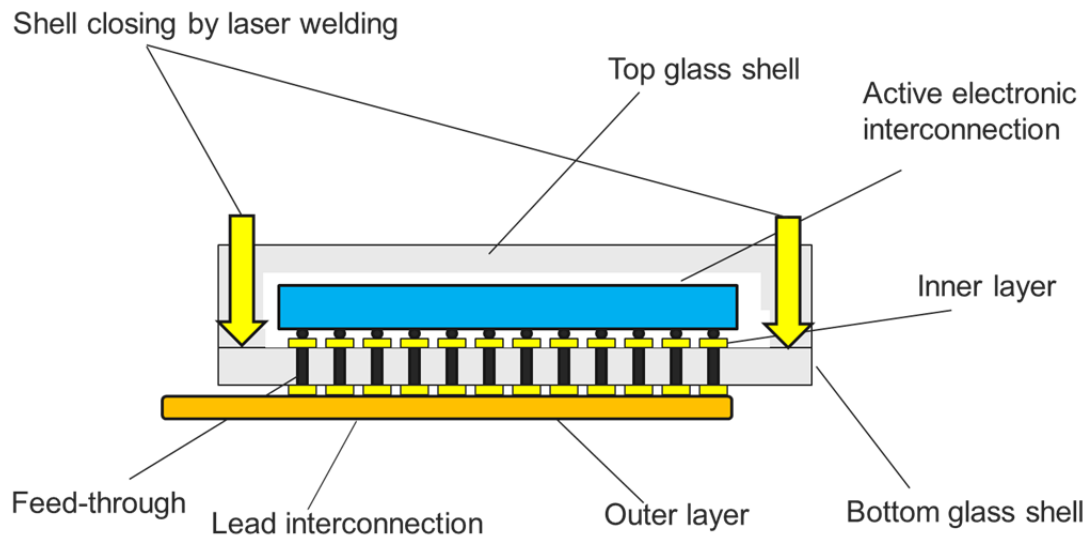

**Figure 3.** The PGE assembly process.

## Advantages of the Valtronic Welding Process

Valtronic has developed a room-temperature pulsed laser welding process specifically for sealing PGE implants under special environmental conditions. The temperature inside the implant's cavity remains at less than 80°C throughout the sealing process, which eliminates the potential for heat damage to the encapsulated circuitry. No auxiliary materials such as intermediate layers or adhesives are involved in the encapsulation process, which helps to maintain glass's high biocompatibility. The process also ensures the implant's high hermeticity, preserving the integrity of embedded elements by protecting them from moisture. At the same time, the process's ability to ensure high hermeticity protects patients from the effects of the breakdown of components and material inside the implant. Valtronic's scientists and its research partners have confirmed this high level of hermeticity through extensive tritium leakage tests, steam tests in autoclaves, and direct helium leakage testing. Shear, pressure, tensile vibration and de-bonding energy tests are used to characterize the mechanical stability of the complete implant package.

## Implant Encapsulation Process

Valtronic researchers in Switzerland are currently refining a three-line process for planar implant encapsulation:

- Process step 1 : Provision of cover glass → metallization (inside/outside)

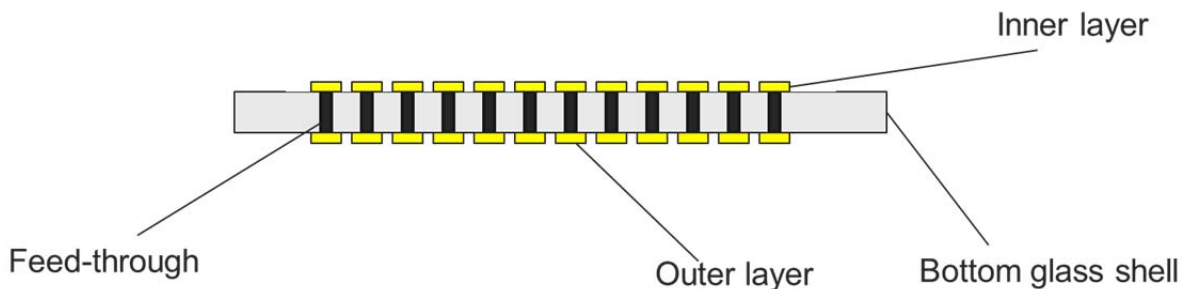

- Process step 2 : Incoming inspection of the electronic device → post curing process → contacting electronic device (inside) → Quality Control (QC) → Curing

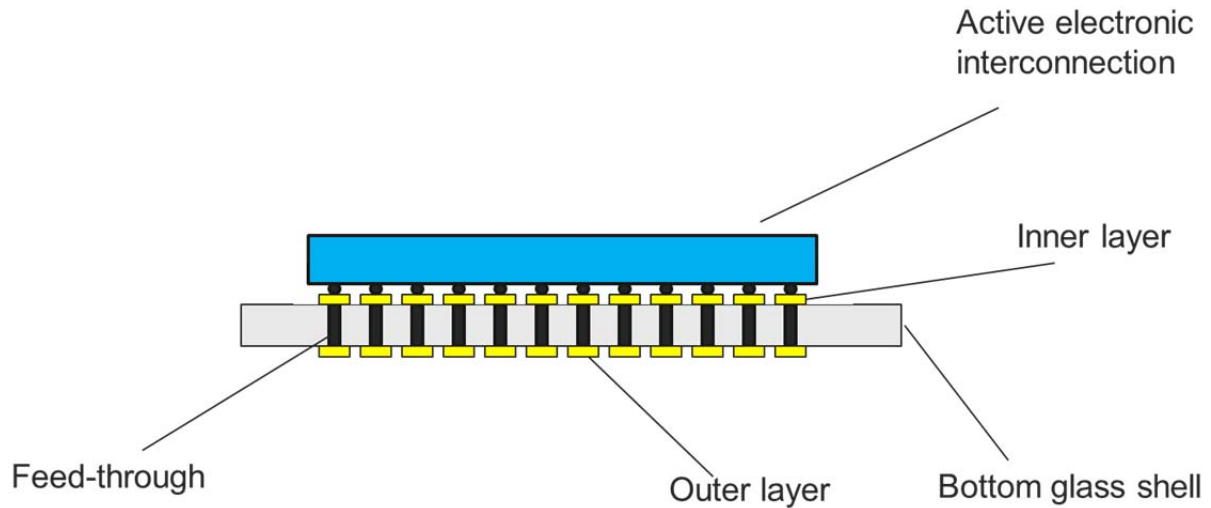

- Process step 3 : Provision of raw material (glass compartment with cavity) → combining with cover glass/preparation for sealing → joining by laser welding (at room temperature and under special environmental conditions) → hermeticity QC → packaging (sterilization upon request, depending on further processes required for finishing implants).

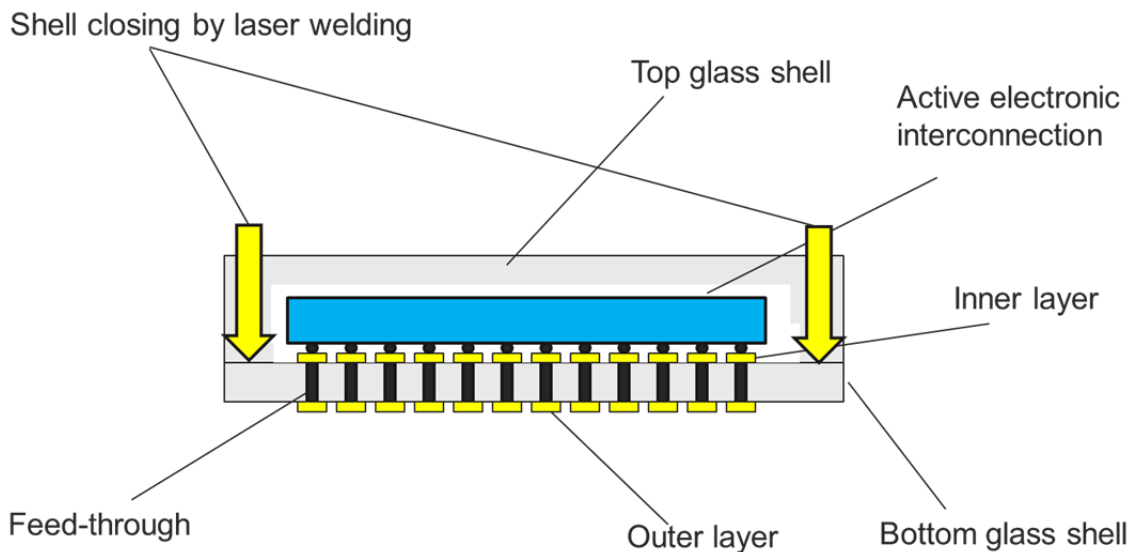

Valtronic is applying innovative design approaches (*Figures 4 and 5*), along with its core competencies in device miniaturization and glass encapsulation, to the development of the next generation of smart implants. This new approach involves wrapping the implant in a 600µm-thick silicone jacket to protect the glass and internal electronics from mechanical stresses. Other components of the design include the two-part planar glass encapsulation, ASIC/MEMS/System-in-Package (SiP) electronic component, wire bonded/flip chip



interconnections, gold stud bumps, and electrode leads. The whole implant design is just 2.55 millimeters thick, making it small enough for implantation in many different parts of the body.

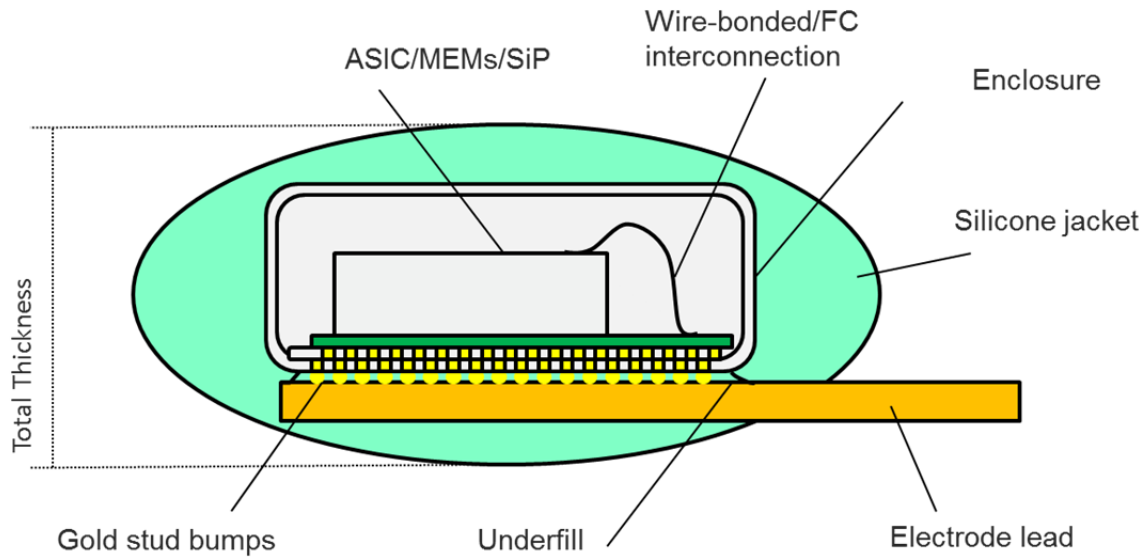

**Figure 4.** New Valtronic PGE implant design (side view)

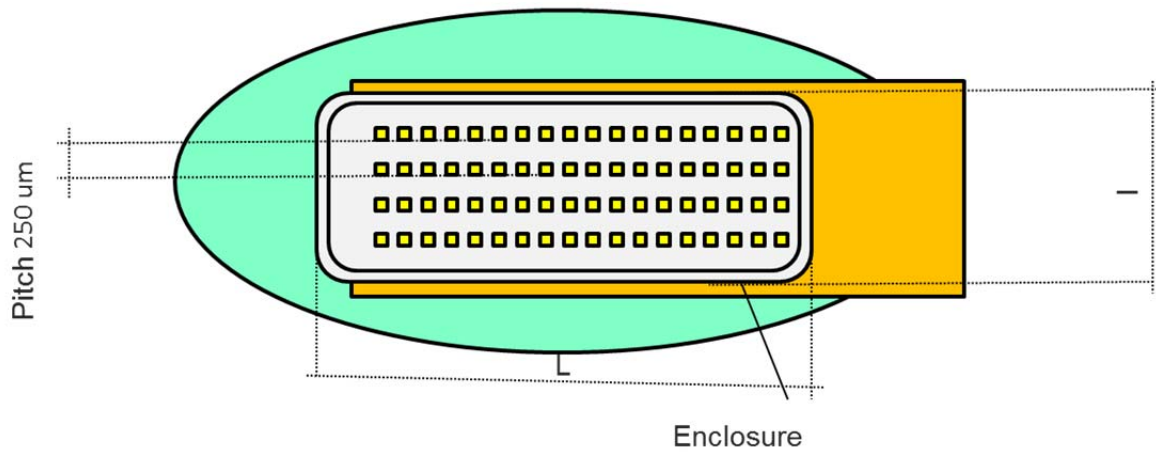

**Figure 5.** New Valtronic PGE implant design (top-down view).

This proposed design approach is in line with the industry requirements for:

- Patient safety (through the use of proven biocompatible materials)
- Longer device autonomy

- Ease of communicating data (due to the RF transparency of glass)
- Minimal invasiveness (due to miniaturization and functionalized encapsulation, allowing greater system integration) and
- Improved interaction with biologic elements for more accurate measurement and stimulation (due to the higher density of feed-throughs).

To learn more about our unique capabilities in implant design and development, or to learn more about our engineering consulting or manufacturing expertise, contact your nearest Valtronic office.

# # #

**Contact**

Valtronic  
29200 Fountain Pkwy, Solon, OH  
440 349 1239 · 440 349 1040  
[inquireusa@valtronic.com](mailto:inquireusa@valtronic.com) · [www.valtronic.com](http://www.valtronic.com)